

EXPORT EQUIPMENT CATALOGUE



C-LINE LIFTING EQUIPMENT AND ORIGINAL ACCESSORIES EFFECTIVE FROM JANUARY 2024



automotive service equipment

REL. MARCH 2024

Nexion SpA reserves the right to change the specifications of its products at any time without prior notice. The company declines all responsibility in the event of claims deriving from the use of non-original accessories or spare parts with consequent forfeiture of the EC declaration of conformity.

MONDOLFO FERRO



NUOVO

2

□ : STANDARD

★ : Compatible

- : NOT Compatible

REL. 03_2024

SUMMARY

ELECTRO-HYDRAULIC TWO POST LIFTS

TITAN PI 255HC	4
TITAN PI 245HC	4
COMPULSORY ACCESSORIES FOR - TITAN PI 255HC - TITAN PI 245HC	5
OPTIONAL ACCESSORIES FOR - TITAN PI 255HC - TITAN PI 245HC	6
TITAN PI 245HC B	6
TITAN PI 235HC B	7
COMPULSORY ACCESSORIES FOR - TITAN PI 245HC B - TITAN PI 235HC B	8
OPTIONAL ACCESSORIES FOR - TITAN PI 245HC B - TITAN PI 235HC B	9

ELECTRO-HYDRAULIC UNDERBODY SCISSORS TYPE LIFTS

TITAN XC1360 B	10
TITAN XC1320 B	11
COMPULSORY ACCESSORIES FOR - TITAN XC1360 B - TITAN XC1320 B	12
OPTIONAL ACCESSORIES FOR - TITAN XC1360 B - TITAN XC1320 B	12

LOW PROFILE DOUBLE SCISSORS LIFTS

TITAN XC 3200 EF	14
TITAN XC 3600 EF	15
COMPULSORY ACCESSORIES FOR - TITAN XC 3200 EF - TITAN XC 3600 EF	16
OPTIONAL ACCESSORIES FOR - TITAN XC 3200 EF - TITAN XC 3600 EF	16

HIGH PROFILE DOUBLE SCISSORS LIFTS

TITAN XC 2036T E	18
TITAN XC 2040T E	19
COMPULSORY ACCESSORIES FOR - TITAN XC 2036T E - TITAN XC 2040T E	20
OPTIONAL ACCESSORIES FOR - TITAN XC 2036T E - TITAN XC 2040T E	20

LOW PROFILE PLATFORM SCISSORS LIFTS

TITAN X 575C CT LT	22
TITAN X 575C CT	23
TITAN X 572C	24
TITAN X 464C CT LT	25
TITAN X 464C CT	26
TITAN X 462C	27
OPTIONAL ACCESSORIES TITAN X575C - TITAN X572C - TITAN X464C - TITAN X462C SERIES	28

MONDOLFO FERRO



NUOVO

ELECTRO-HYDRAULIC TWO POST LIFTS

TITAN PI 255HC



MAIN FEATURES:

- Capacity: 5.500 kg.
- Possibility of installation in symmetrical or asymmetric version.
- Lifting system: with hydraulic cylinders and synchronisation with wire ropes on the column top.
- Standard height of two-post connection: 4.050 mm.
- Single motor.
- Electro magnet safety release 24V.
- Three-stage symmetric arms with pads adjustable in height and extensions supplied as standard.
- Anticrushing safety bar as standard.
- Minimum lifting height: 100 mm.
- Maximum lifting height: 2.080 mm.

Also available versions (with optional column extension set):

- V: High version specific for vans (Height of two-post connection: 4.620 mm).
- XV: Extra-above version specific for vans and very high vehicles (Height two-post connection: 5.220 mm).

PN	Power supply	Description	
0-43107700 /15	400V/3Ph/50-60Hz	TITAN PI 255HC - Red RAL 3002 Orange peel - Capacity 5.500 kg.	
0-43107702 /15	230V/1Ph/50Hz	TITAN PI 255HC - Red RAL 3002 Orange peel - Capacity 5.500 kg.	
0-43107703 /15	230V/1Ph/60Hz	TITAN PI 255HC - Red RAL 3002 Orange peel - Capacity 5.500 kg.	
8-43300216			

ELECTRO-HYDRAULIC TWO POST LIFTS

TITAN PI 245HC



MAIN FEATURES:

- Capacity: 4.500 kg.
- Possibility of installation in symmetrical or asymmetric version.
- Lifting system: with hydraulic cylinders and synchronisation with wire ropes on the column top.
- Standard height of two-post connection: 4.050 mm.
- Single motor.
- Electro magnet safety release 24V.
- Three-stage symmetric arms with pads adjustable in height and extensions supplied as standard.
- Anticrushing safety bar as standard.
- Minimum lifting height: 100 mm.
- Maximum lifting height: 2.080 mm.

Also available versions (with optional column extension set):



- V: High version specific for vans (Height of two-post connection: 4.620 mm).
- XV: Extra-above version specific for vans and very high vehicles (Height of two-post connection: 5.220 mm).

PN	Power supply	Description	
0-43107800 /15	400V/3Ph/50-60Hz	TITAN PI 245HC - Red RAL 3002 Orange peel - Capacity 4.500 kg.	
0-43107802 /15	230V/1Ph/50Hz	TITAN PI 245HC - Red RAL 3002 Orange peel - Capacity 4.500 kg.	
0-43107803 /15	230V/1Ph/60Hz	TITAN PI 245HC - Red RAL 3002 Orange peel - Capacity 4.500 kg.	
8-43300217			

COMPULSORY ACCESSORIES FOR - TITAN PI 255HC - TITAN PI 245HC

Picture	PN	Description
	8-43100161	Set of masonry screws (16 pcs.) For all models in the range.

OPTIONAL ACCESSORIES FOR - TITAN PI 255HC - TITAN PI 245HC

Picture	PN	Description
	8-43100224/15	Column extension set L= 570 mm - (H= 4.620 mm)*.
	8-43100225/15	Column extension set L= 1.170 mm - (H= 5.220 mm)*. *: Not available for TITAN PI 265HC.
	8-43100205	Manual emergency descent pump.

ELECTRO-HYDRAULIC TWO POST LIFTS

TITAN PI 245HC B



MAIN FEATURES:

- Capacity: 4.500 kg.
- Single motor.
- Lifting system: with hydraulic cylinders and synchronisation with wire ropes on the column base.
- Three-stage asymmetric arms with pads adjustable in height and extensions supplied as standard.
- Minimum lifting height: 95 mm.
- Maximum lifting height: 1.945 mm

PN	Power supply	Description	
0-43107400 /48	400V/3Ph/50-60Hz	TITAN PI 245HC B - Grey RAL 7040 Orange peel - Capacity 4.500 kg.	
0-43107402 /48	230V/1Ph/50Hz	TITAN PI 245HC B - Grey RAL 7040 Orange peel - Capacity 4.500 kg.	
0-43107403 /48	230V/1Ph/60Hz	TITAN PI 245HC B - Grey RAL 7040 Orange peel - Capacity 4.500 kg.	
8-43300214		Customization kit for TITAN PI 245HC B (Compulsory)	

Other colors than the standard are NOT currently provided

ELECTRO-HYDRAULIC TWO POST LIFTS

TITAN PI 235HC B



MAIN FEATURES:

- Capacity: 3.500 kg.
- Single motor.
- Lifting system: with hydraulic cylinders and synchronisation with wire ropes on the column base.
- Three-stage asymmetric arms with pads adjustable in height and extensions supplied as standard.
- Minimum lifting height: 95 mm.
- Maximum lifting height: 1.945 mm



PN	Power supply	Description	
0-43107500 /48	400V/3Ph/50-60Hz	TITAN PI 235HC B - Grey RAL 7040 Orange peel - Capacity 3.500 kg.	
0-43107502 /48	230V/1Ph/50Hz	TITAN PI 235HC B - Grey RAL 7040 Orange peel - Capacity 3.500 kg.	
0-43107503 /48	230V/1Ph/60Hz	TITAN PI 235HC B - Grey RAL 7040 Orange peel - Capacity 3.500 kg.	
8-43300212		Customization kit for ERCO HC3502 B (Compulsory)	

Other colors than the standard are NOT currently provided

COMPULSORY ACCESSORIES FOR - TITAN PI 245HC B - TITAN PI 235HC B

Picture	PN	Description	
	8-43100233	Set of masonry screws (10 pcs.) For all models in the range.	

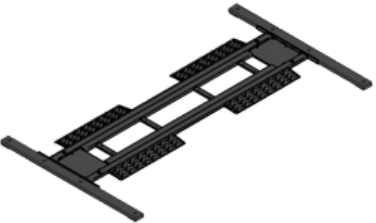
OPTIONAL ACCESSORIES FOR - TITAN PI 245HC B - TITAN PI 235HC B

Picture	PN	Description	
	8-43100222	Main frame kit RAL7016 (To be order in case of location with critical floors).	
	8-43100205	Manual emergency descent pump.	

ELECTRO-HYDRAULIC UNDERBODY SCISSORS TYPE LIFTS

TITAN XC1360 B

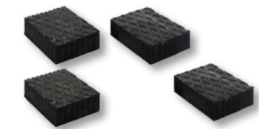

All models supplied with:
- 1 Set of 4 hard rubber blocks.



MAIN FEATURES:

- Capacity: 3.600 kg.
- For tyre specialists, car workshops and body repairers.
- Alignment of the runways by 2 anti-torsion connection bars.
- Built-in ascent and descent ramps to the runways.
- Automatic engagement of mechanical safety locks with pneumatic release system.
- Equipped with anti-crushing foot guard.
- Low voltage control unit with «dead-man» control system.
- Low profile configuration for on-floor installations.
- Runboard height from ground: 115 mm.
- Max. lifting height: 1000 mm.
- Runboard length: 2.040 (open ramps)

PN	Power supply	Description	
0-41106600/15	230-400V/3Ph/50-60Hz	TITAN XC1360 B - Red RAL 3002 Orange peel - Capacity 3.600 kg.	
0-41106602/15	230V/1Ph/50Hz	TITAN XC1360 B - Red RAL 3002 Orange peel - Capacity 3.600 kg.	
0-41106603/15	230V/1Ph/60Hz	TITAN XC1360 B - Red RAL 3002 Orange peel - Capacity 3.600 kg.	
8-41300195		Customization kit for TITAN XC1360 B (Compulsory)	

ELECTRO-HYDRAULIC UNDERBODY SCISSORS TYPE LIFTS

TITAN XC1320 B

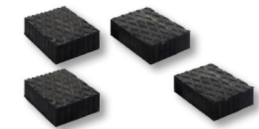

All models supplied with:
- 1 Set of 4 hard rubber blocks.



MAIN FEATURES:



- Capacity: 3.200 kg.
- For tyre specialists, car workshops and body repairers.
- Alignment of the runways by 2 anti-torsion connection bars.
- Built-in ascent and descent ramps to the runways.
- Automatic engagement of mechanical safety locks with pneumatic release system.
- Equipped with anti-crushing foot guard.
- Low voltage control unit with «dead-man» control system.
- Low profile configuration for on-floor installations.
- Runboard height from ground: 115 mm.
- Max. lifting height: 1000 mm.
- Runboard length: 2.040 (open ramps)

PN	Power supply	Description	
0-41106500/15	230-400V/3Ph/50-60Hz	TITAN XC1320 B - Red RAL 3002 Orange peel - Capacity 3.200 kg.	
0-41106502/15	230V/1Ph/50Hz	TITAN XC1320 B - Red RAL 3002 Orange peel - Capacity 3.200 kg.	
0-41106503/15	230V/1Ph/60Hz	TITAN XC1320 B - Red RAL 3002 Orange peel - Capacity 3.200 kg.	
8-41300194		Customization kit for TITAN XC1320 B (Compulsory)	

COMPULSORY ACCESSORIES FOR - TITAN XC1360 B - TITAN XC1320 B

Picture	PN	Description
	8-41100203	Set of masonry screws (8 pcs.) For all models in the range.

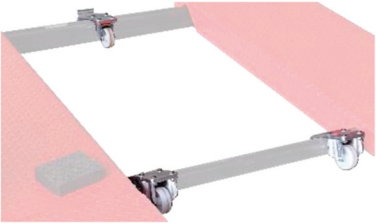
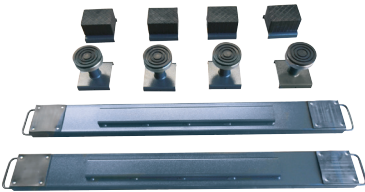
OPTIONAL ACCESSORIES FOR - TITAN XC1360 B - TITAN XC1320 B

Picture	PN	Description
	8-41100320	M320 Moving wheel set for mobile version. Available for model TITAN XC1320 B only. NOTE: The lift with the mounted accessory is downgraded to 3000 kg. and is not reversible
	8-42300047	Crossbar set (2 bars and 4 pads), L=1800 mm.
	8-42300027	Pad set (4 pcs.) H= 80 mm.

OPTIONAL ACCESSORIES FOR - TITAN XC1360 B - TITAN XC1320 B

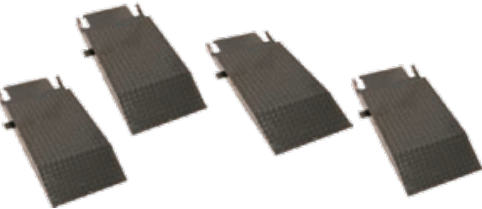
Picture	PN	Description	
	8-44600003	Long ramps for vehicles with spoiler having length 1.200 mm (4 pcs).	

LOW PROFILE DOUBLE SCISSORS LIFTS

TITAN XC 3200 EF

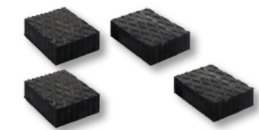

All models supplied with:
- 1 Set of 4 hard rubber blocks.



MAIN FEATURES:

- Low profile double scissor lift.
- Alignment of the runways with a dual MASTER/SLAVE circuit without mechanical safety racks.
- Runboards version with flaps (F).
- Capacity: 3.200 kg

PN	Power supply	Description	
0-41106000/15	230-400V/3Ph/50-60Hz	TITAN XC3200 EF - Red RAL 3002 Orange peel - Capacity 3.200 kg.	
0-41106002/15	230V/1Ph/50Hz	TITAN XC3200 EF - Red RAL 3002 Orange peel - Capacity 3.200 kg.	
0-41106003/15	230V/1Ph/60Hz	TITAN XC3200 EF - Red RAL 3002 Orange peel - Capacity 3.200 kg.	
8-41300189		Customization kit for TITAN XC 3200 EF (Compulsory)	

LOW PROFILE DOUBLE SCISSORS LIFTS

TITAN XC 3600 EF

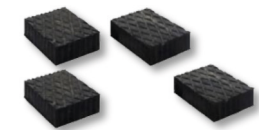

All models supplied with:
- 1 Set of 4 hard rubber blocks.



MAIN FEATURES:

- Low profile double scissor lift.
- Alignment of the runways with a dual MASTER/SLAVE circuit without mechanical safety racks.
- Runboards version with flaps (F).
- Capacity: 3.600 kg

PN	Power supply	Description	
0-41106100/15	230-400V/3Ph/50-60Hz	TITAN XC3600 EF - Red RAL 3002 Orange peel - Capacity 3.600 kg.	
0-41106102/15	230V/1Ph/50Hz	TITAN XC3600 EF - Red RAL 3002 Orange peel - Capacity 3.600 kg.	
0-41106103/15	230V/1Ph/60Hz	TITAN XC3600 EF - Red RAL 3002 Orange peel - Capacity 3.600 kg.	
8-41300190		Customization kit for TITAN XC 3600 EF (Compulsory)	



COMPULSORY ACCESSORIES FOR - TITAN XC 3200 EF - TITAN XC 3600 EF

Picture	PN	Description
	8-41100203	Set of masonry screws (8 pcs.) For all models in the range.

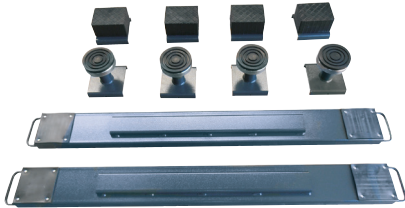
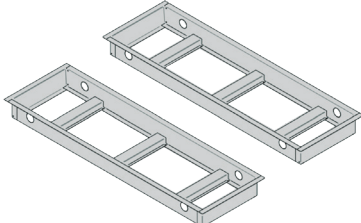
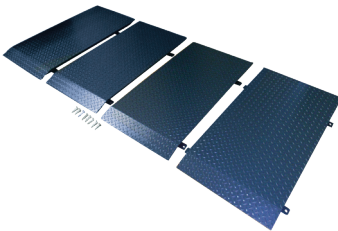
OPTIONAL ACCESSORIES FOR - TITAN XC 3200 EF - TITAN XC 3600 EF

Picture	PN	Description
	8-42300047	Off-the-road vehicle cross bar (2 pcs).
	8-41100225	Flush installation frame set (galvanized) for C-line underbody low profile double scissor lifts with flaps (must be combined with 8-41100165)
	8-41100207	Set of long ramps for on-floor version

OPTIONAL ACCESSORIES FOR - TITAN XC 3200 EF - TITAN XC 3600 EF

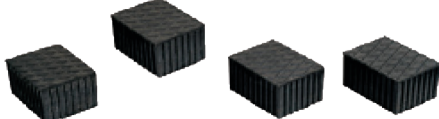
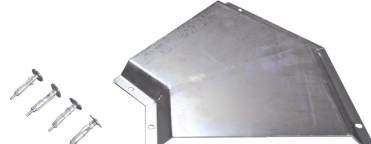
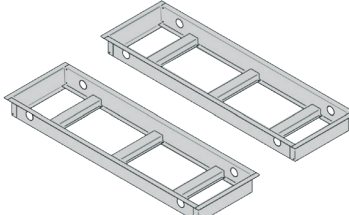
Picture	PN	Description	
	8-41100184	Extensions for pipes and cables L= 1 mt. (protection covers included.)	
	8-41100185	Extensions for pipes and cables L= 2 mt. (protection covers included.)	
	8-42300027	Kit of 4 rubber blocks height 80 mm.	
	8-41100143	Angle pipe protection cover	
	8-41100165	In-pit installation kit for lifts with flaps, incl. support for flaps that must be bolted to the ground mandatory for recessed installation	

HIGH PROFILE DOUBLE SCISSORS LIFTS

TITAN XC 2036T E



MAIN FEATURES:

- Inground double scissor lift.
- Alignment of the runways with a dual MASTER/SLAVE circuit.
- Capacity: 3.600 kg

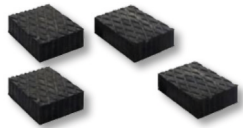

All models supplied with:
- 1 Set of 4 hard rubber blocks.

PN	Power supply	Description	
0-41106300/15	230-400V/3Ph/50-60Hz	TITAN XC 2036T E - Red RAL 3002 Orange peel - Capacity 3.600 kg.	
0-41106302/15	230V/1Ph/50Hz	TITAN XC 2036T E - Red RAL 3002 Orange peel - Capacity 3.600 kg.	
0-41106303/15	230V/1Ph/60Hz	TITAN XC 2036T E - Red RAL 3002 Orange peel - Capacity 3.600 kg.	
8-41300192		Customization kit for TITAN XC 2036T E (Compulsory)	

HIGH PROFILE DOUBLE SCISSORS LIFTS

TITAN XC 2040T E



MAIN FEATURES:

- Inground double scissor lift.
- Alignment of the runways with a dual MASTER/SLAVE circuit.
- Capacity: 4.000 kg

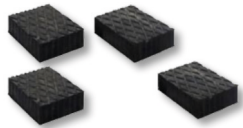
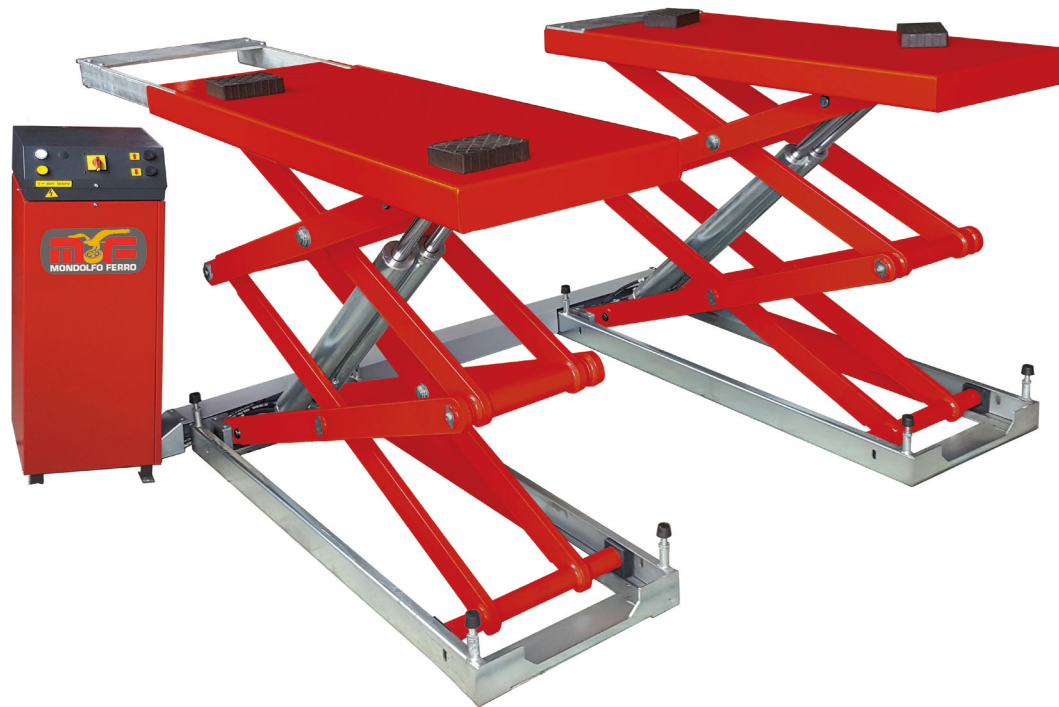



All models supplied with:
- 1 Set of 4 hard rubber blocks.

PN	Power supply	Description	
0-41106400/15	230-400V/3Ph/50-60Hz	TITAN XC 2040T E - Red RAL 3002 Orange peel - Capacity 4.000 kg.	
0-41106402/15	230V/1Ph/50Hz	TITAN XC 2040T E - Red RAL 3002 Orange peel - Capacity 4.000 kg.	
0-41106403/15	230V/1Ph/60Hz	TITAN XC 2040T E - Red RAL 3002 Orange peel - Capacity 4.000 kg.	
8-41300193		Customization kit for TITAN XC 2040T E (Compulsory)	

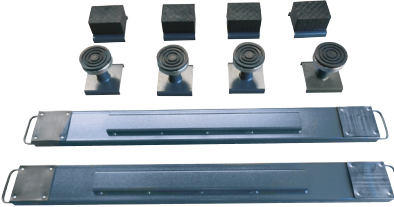
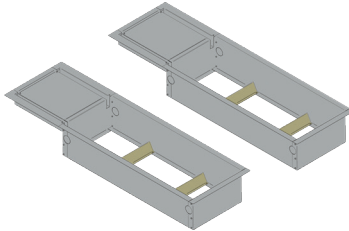

COMPULSORY ACCESSORIES FOR - TITAN XC 2036T E - TITAN XC 2040T E

Picture	PN	Description
	8-41100203	Set of masonry screws (8 pcs.) For all models in the range.

OPTIONAL ACCESSORIES FOR - TITAN XC 2036T E - TITAN XC 2040T E

Picture	PN	Description
	8-42300047	Off-the-road vehicle cross bar (2 pcs).
	8-41100204	Flush installation frame set for lifts
	8-41100184	Extensions for pipes and cables L= 1 mt. (protection covers included.)

OPTIONAL ACCESSORIES FOR - TITAN XC 2036T E - TITAN XC 2040T E

Picture	PN	Description	
	8-41100185	Extensions for pipes and cables L= 2 mt. (protection covers included.)	
	8-42300027	Kit of 4 rubber blocks height 80 mm.	

LOW PROFILE PLATFORM SCISSORS LIFTS

TITAN X 575C CT LT

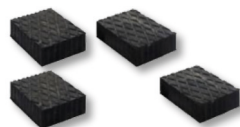

All models supplied with:
- 1 Set of 4 hard rubber blocks.



MAIN FEATURES:

- Low profile platform scissor lift with lifting table for wheel alignment.
- Automatic runway levelling system with master/slave hydraulic circuit.
- Capacity: 5.500 kg
- way length: 4600 mm / 5200 mm

DELIVERY AVAILABE FROM CHINA ONLY

PN	Power supply	Description	
0-42116000/15	230-400V/3Ph/50-60Hz	TITAN X 575C CT LT , with LT lift table, runway length 4600 mm	
8-42300163		Customization kit TITAN X 575C CT LT, compulsory	
0-42116010/15	230-400V/3Ph/50-60Hz	TITAN X 575C CT LT I , with LT lift table, runway length 4600 mm, in-pit installation	
8-42300223		Customization kit - TITAN X 575C CT LT I, compulsory	
0-42116500/15	230-400V/3Ph/50-60Hz	TITAN X 575C CT LT , with LT lift table, runway length 5200 mm	
8-42300219		Customization kit - TITAN X 575C CT LT, compulsory	
0-42116510/15	230-400V/3Ph/50-60Hz	TITAN X 575C CT LT I , with LT lift table, runway length 5200 mm, in-pit installation	
8-42300224		Customization kit - TITAN X 575C CT LT I, compulsory	

LOW PROFILE PLATFORM SCISSORS LIFTS

TITAN X 575C CT

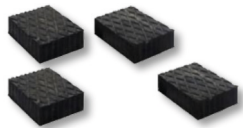

MAIN FEATURES:

- Low profile platform scissor lift for wheel alignment.
- Automatic runway levelling system with master/slave hydraulic circuit.
- Capacity: 5.500 kg
- Runway length: 4600 mm / 5200 mm

DELIVERY AVAILABE FROM CHINA ONLY

All models supplied with:
- 1 Set of 4 hard rubber blocks.

PN	Power supply	Description	
0-42112100/15	230-400V/3Ph/50-60Hz	TITAN X 575C CT , runway length 4600 mm	
8-42300164		Customization kit TITAN X 575C CT, compulsory	
0-42112110/15	230-400V/3Ph/50-60Hz	TITAN X 575C CT I , runway length 4600 mm, in-pit installation	
8-42300226		Customization kit - TITAN X 575C CT I, compulsory	
0-42116600/15	230-400V/3Ph/50-60Hz	TITAN X 575C CT , runway length 5200 mm	
8-42300220		Customization kit - TITAN X 575C CT, compulsory	
0-42116610/15	230-400V/3Ph/50-60Hz	TITAN X 575C CT I , runway length 5200 mm, in-pit installation	
8-42300227		Customization kit - TITAN X 575C CT I, compulsory	

LOW PROFILE PLATFORM SCISSORS LIFTS

TITAN X 572C



5.500 kg

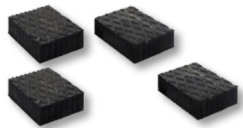

All models supplied with:
- 1 Set of 4 hard rubber blocks.



MAIN FEATURES:

- Low profile platform scissor lift for service/inspection.
- Automatic runway levelling system with master/slave hydraulic circuit.
- Capacity: 5.500 kg
- Runway length: 4600 mm / 5200 mm

DELIVERY AVAILABE FROM CHINA ONLY

PN	Power supply	Description	
0-42112300/15	230-400V/3Ph/50-60Hz	TITAN X 572C , runway length 4600 mm	
8-42300166		Customization kit TITAN X 572C , compulsory	
0-42112310/15	230-400V/3Ph/50-60Hz	TITAN X 572C I , runway length 4600 mm, in-pit installation	
8-42300229		Customization kit - TITAN X 572C I, compulsory	
0-42116800/15	230-400V/3Ph/50-60Hz	TITAN X 572C , runway length 5200 mm	
8-42300221		Customization kit - TITAN X 572C, compulsory	
0-42116810/15	230-400V/3Ph/50-60Hz	TITAN X 572C I , runway length 5200 mm, in-pit installation	
8-42300230		Customization kit - TITAN X 572C I, compulsory	

LOW PROFILE PLATFORM SCISSORS LIFTS

TITAN X 464C CT LT



MAIN FEATURES:

- Low profile platform scissor lift with lifting table for wheel alignment.
- Automatic runway levelling system with master/slave hydraulic circuit.
- Capacity: 4.500 kg
- way length: 4200 mm



All models supplied with:
- 1 Set of 4 hard rubber blocks.

DELIVERY AVAILABE FROM CHINA ONLY

PN	Power supply	Description	
0-42116100/15	230-400V/3Ph/50-60Hz	TITAN X 464C CT LT , with LT lift table, runway length 4200 mm	
8-42300167		Customization kit - TITAN X 464C CT LT, compulsory	
0-42116110/15	230-400V/3Ph/50-60Hz	TITAN X 464C CT LT I , with LT lift table, runway length 4200 mm, in-pit installation	
8-42300222		Customization kit - TITAN X 464C CT LT I, compulsory	

LOW PROFILE PLATFORM SCISSORS LIFTS

TITAN X 464C CT



MAIN FEATURES:

- Low profile platform scissor lift for wheel alignment.
- Automatic runway levelling system with master/slave hydraulic circuit.
- Capacity: 4.500 kg
- Runway length: 4200 mm

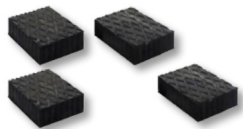

All models supplied with:
- 1 Set of 4 hard rubber blocks.

DELIVERY AVAILABE FROM CHINA ONLY

PN	Power supply	Description	
0-42116200/15	230-400V/3Ph/50-60Hz	TITAN X 464C CT , runway length 4200 mm	
8-42300168		Customization kit - TITAN X 464C CT, compulsory	
0-42116210/15	230-400V/3Ph/50-60Hz	TITAN X 464C CT I , runway length 4200 mm, in-pit installation	
8-42300225		Customization kit - TITAN X 464C CT I, compulsory	

LOW PROFILE PLATFORM SCISSORS LIFTS

TITAN X 462C



MAIN FEATURES:

- Low profile platform scissor lift for service/inspection.
- Automatic runway levelling system with master/slave hydraulic circuit.
- Capacity: 4.500 kg
- Runway length: 4200 mm

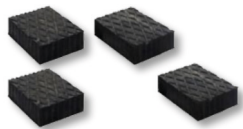



All models supplied with:
- 1 Set of 4 hard rubber blocks.

DELIVERY AVAILABE FROM CHINA ONLY

PN	Power supply	Description	
0-42116400/15	230-400V/3Ph/50-60Hz	TITAN X 462C , runway length 4200 mm	
8-42300170		Customization kit - TITAN X 462C, compulsory	
0-42116410/15	230-400V/3Ph/50-60Hz	TITAN X 462C I , runway length 4200 mm, in-pit installation	
8-42300228		Customization kit - TITAN X 462C I, compulsory	

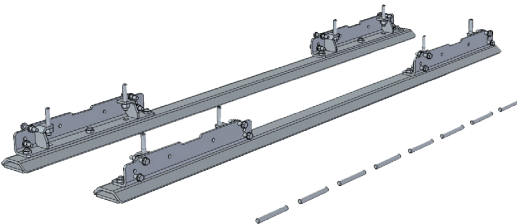
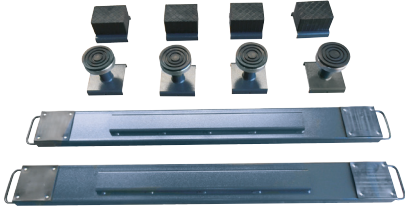
OPTIONAL ACCESSORIES FOR - TITAN X575C - TITAN X572C - TITAN X464C - TITAN X462C SERIES

Picture	PN	Description	
	8-42100218	Set of cross bars , to be ordered with the lift, compulsory for usage of 2 jacking beams, recommended for wheel alignment, standard colour grey RAL 7016 fixed	
	8-42300047	Off-the-road vehicle cross bar (2 pcs).	
	8-42300027	Kit of 4 rubber blocks height 80 mm.	
	8-42100183	Pipe extensions kit L= 2m (for lifts with LT)	
	8-42100184	Pipe extensions kit L= 4m (for lifts with LT)	
	8-42100173	Pipe extensions kit L= 2m (for lifts without LT)	
	8-42100174	Pipe extensions kit L= 4m (for lifts without LT)	

OPTIONAL ACCESSORIES FOR - TITAN X575C - TITAN X572C - TITAN X464C - TITAN X462C SERIES

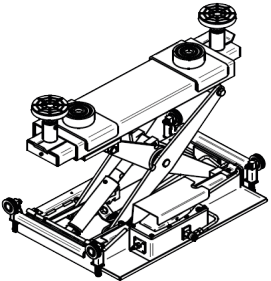
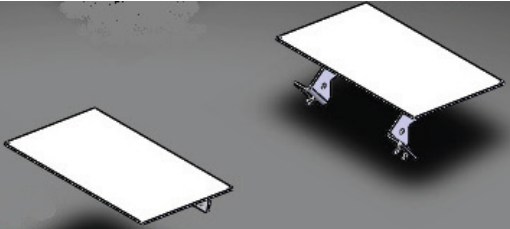
Picture	PN	Description	
	8-42100185	Complete low-voltage lighting kit .	
	J804-0000000	Scissor Jack 2,2 ton. Gray Ral 7016.	
	8-42100234/00	Transformation kit from surface-mounted to recessed installation	

AUTOMOTIVE SERVICE EQUIPMENT



www.facebook.com/MONDOLFOFERROofficial/



<http://www.youtube.com/user/MondolfoFerro>

NEXION S.p.A.
Viale Dell'Industria, 20 - 61037 MONDOLFO (PU) ITALY
Tel. 0721.93671 - Telefax 0721.930232
info@mondolfoferro.it - www.mondolfoferro.it

